

Varenummer: 4395000701
Beskrivelse: Rota-fix spændelement F70x110
Rustfast stål

Mål

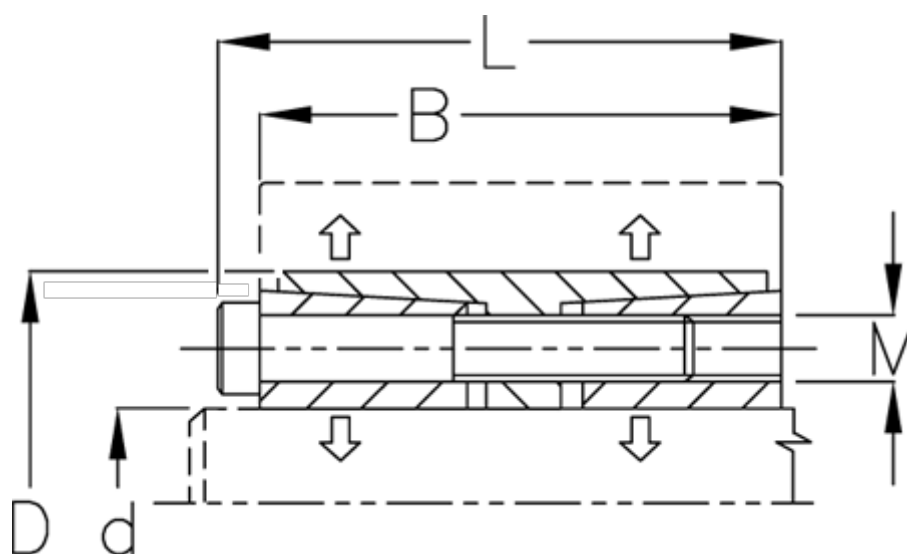

B mm	= 80
d H8 mm	= 70
D mm	= 110
F kN aksialkraft	= 179.0
L mm	= 90
M mm	= M10
Overfladeruhed	= R? ? 3.2 μ m
P N/mm ² fladetryk på aksel/nav	= 37

T Nm drejningsmoment	= 6270
Tolerance	= Aksel h8, Nav H8
Ts Nm boltetilspændingsmoment	= 58.0